

RelyX™ Fiber Post

Glass Fiber Post



Technical Product Profile



Table of Contents

1. INTRODUCTION	5
2. INDICATIONS.....	5
3. CLINICALLY RELEVANT PRODUCT PROPERTIES	6
3.1. Material Properties	6
3.1.1. Sizes	6
3.1.2. Shape	6
3.1.3. Radiopacity	6
3.1.4. Composition.....	7
3.2. The Shift from Metal Posts to Fiber Posts	7
3.2.1. Translucency	7
3.2.2. Elasticity	8
3.3. The Long-Lasting Post.....	9
3.3.1. Fatigue Test.....	9
3.3.2. 1-Point Flexural Strength Test	9
3.4. The Best Way to Cement It	11
3.4.1. The Reliable Bond	12
Adhesion of RelyX™ Unicem Cement to RelyX™ Fiber Post.....	12
Adhesion of RelyX™ Unicem Cement to Root Dentin	13
Marginal Sealing in RelyX™ Fiber Post Treated Teeth	14
3.4.2. The Smart Application	15
Virtually Void-Free Cement Application.....	15
3.5. The Secure Core.....	16
4. TECHNIQUE GUIDE	17
5. LITERATURE.....	19



1. Introduction

Over the past decade fiber reinforced composite (FRC) posts have gained popularity in the dental market because of their benefits regarding mechanical properties, esthetics and removability, offering predictable clinical performance in several ways.

- a) The risk of root fractures is significantly reduced with fiber posts. Stiff and hard metal posts exert a “wedge effect” that can be compared to that of a metal wedge in a piece of wood. Fiber posts avoid this effect because of the dentin-like elastic properties.
- b) Esthetic demands of full-ceramic restorations are met by fiber posts due to their natural translucency.
- c) In case the endodontic treatment has to be redone, fiber posts can be easily removed with drills.

Despite these clear advantages and the paradigm shift from metal to fiber posts that is also reflected in the scientific community, there is one drawback: fiber posts have to be adhesively cemented into the root canal which is difficult for its multi-step, moisture sensitive adhesive protocols. Market research has shown that many dentists expect difficulties with the complex cementation procedure of fiber posts in the root canal and as a consequence do not use them.

RelyX™ Fiber Post Glass Fiber Posts and RelyX™ Unicem Self-Adhesive Universal Resin Cement in the Aplicap™ Capsule with the RelyX™ Unicem Elongation Tip offer the solution:

RelyX Unicem cement offers safe and reliable adhesion without any pretreatment neither of the root canal dentin (i.e. etching, priming, and bonding) nor the RelyX Fiber Post (e.g. silanating or roughening). The RelyX Unicem elongation tip allows the application of RelyX Unicem cement into the root canal in one single step. The elongation tip locks securely onto the RelyX Unicem Aplicap nozzle via a simple hook mechanism. The system allows easy, time-saving, and virtually void-free cementation of the RelyX Fiber Post.

Advantages

- RelyX Fiber Post is a radiopaque, translucent, glass-fiber reinforced composite root post.
- RelyX Fiber Post is an esthetic, conservative, and reliable restoration for severely destroyed teeth.
- RelyX Fiber Posts are offered in a hygienic and easy to use blister pack.
- RelyX Unicem cement in the Aplicap capsule is used for a safe and reliable bond between the root post and the root canal dentin without any pretreatment.
- RelyX Unicem Aplicap elongation tips allow easy, time-saving, and virtually void-free cementation of root posts with RelyX Unicem cement.

2. Indications

In case of insufficient residual tooth structure (<4 mm) the post is needed to support and secure the coronal restoration.

RelyX™ Fiber Posts and drills are available in three sizes and are color-coded to ensure an accurate match and prevent errors.

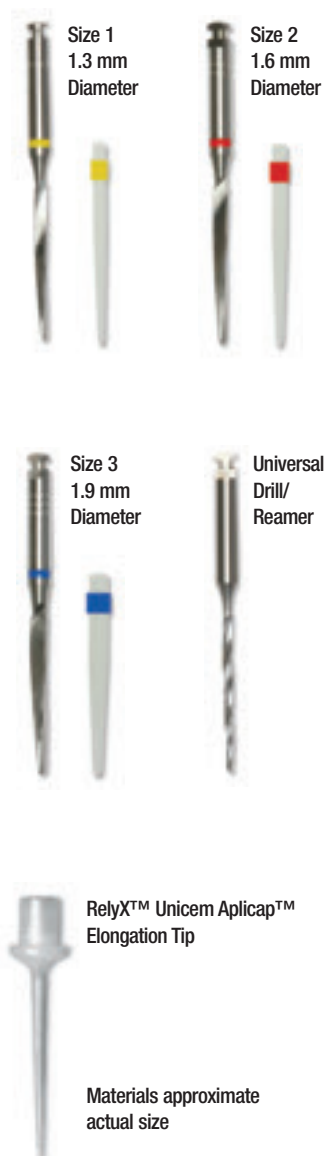

The RelyX™ Fiber Post system comes with a universal pre-drill, three sizes drills and RelyX™ Unicem Aplicap™ Elongation Tips to dispense the cement into the root canal for virtually void-free cement application.



Tab. 1: RelyX™ Fiber Post color coding and sizes

3. Clinically Relevant Product Properties

3.1. Material Properties

3.1.1. Sizes

RelyX™ Fiber Post Glass Fiber Posts and drills are available in three sizes and are color-coded to ensure an accurate match.

Post color code	Yellow	Red	Blue
Diameter of apical post end (mm)	0.70	0.80	0.90
Diameter of coronal post end (mm)	1.30	1.60	1.90
Taper	3.44° (6%)	4.58° (8%)	5.72° (10%)
Length	20 mm	20 mm	20 mm

RelyX™ Unicem Aplicap™ Elongation Tips are designed to also fit into root canals prepared for the smallest size RelyX Fiber Post (yellow).

3.1.2. Shape

RelyX Fiber Posts have a tapered shape, i.e. they are parallel-walled (cylindrical) at the coronal end and conical at the apical end. This special design is similar to the anatomical form of the root. Therefore, the root canal preparation can be done in a conservative way, i.e. without overly removing of root canal dentin. Additionally, the transmission of forces from the coronal part into the root area is reduced. The coronal end of the cylindrical part of the RelyX Fiber Posts offers a large surface area for the adhesion of the core build up material and the highest material thickness to withstand mastication forces.

3.1.3. Radiopacity

RelyX Fiber Posts are radiopaque. The radiopacity of RelyX Fiber Posts size 3 (blue) equals approx. 400% +/- 50% Al (Fig. 1). This was confirmed by the independent test institute THE DENTAL ADVISOR (Research Report 20, 2009).



X-ray image of an extracted tooth restored with RelyX™ Fiber Post size 2. (THE DENTAL ADVISOR, Research Report 20, 2009)

Fig. 1: X-ray photograph of various brands of fiber reinforced posts. A standard aluminum ladder is shown for comparison. (3M ESPE internal data)

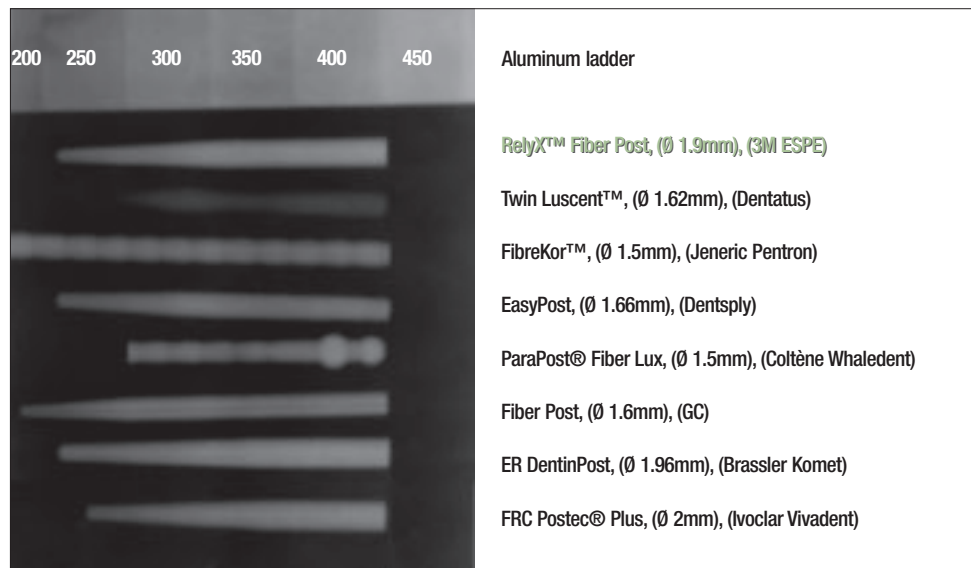

3.1.4. Composition

RelyX™ Fiber Posts are made from glass fibers embedded into a composite resin matrix. For superior mechanical properties the glass fibers have parallel orientation and are distributed equally over the surface area. Additionally, during the manufacturing process the glass fibers are pretensioned for enhanced post stability. Therefore, during the clinical application RelyX Fiber Posts have to be cut with a diamond disc. Wire cutters or instruments alike must not be used (see Technique Guide, page 17f). Otherwise, the glass fibers will be ripped from the composite matrix leading to a loss in mechanical stability. A two-step manufacturing procedure that includes chemical and thermal curing assures a virtually complete curing of the composite resin matrix.

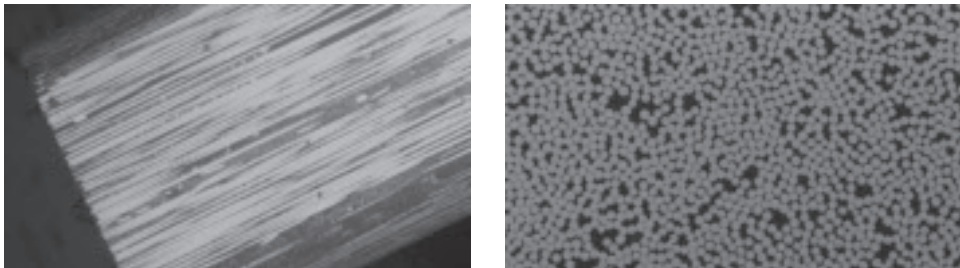

Fig. 2: Longitudinal cut (left) and cross section (right) of a RelyX™ Fiber Post (size 3). Scanning electron microscopy (SEM) images; magnification 60x (longitudinal cut) and 500x (cross-section). Glass fibers are depicted as white lines in the longitudinal cut and white spots in the cross section. Glass fibers are surrounded by composite resin matrix. (3M ESPE internal data)

3.2. The Shift from Metal Posts to Fiber Posts

3.2.1. Translucency

Due to their advantageous combination of mechanical and esthetic properties Fiber Posts have gained increased popularity in recent years. Translucency plays an important role for their remarkable esthetics. RelyX Fiber Posts are translucent (Fig. 3) to meet the particular needs of highly esthetic anterior restorations (e.g. full ceramic restorations). During the post cementation the translucency facilitates light-curing in the root canal.

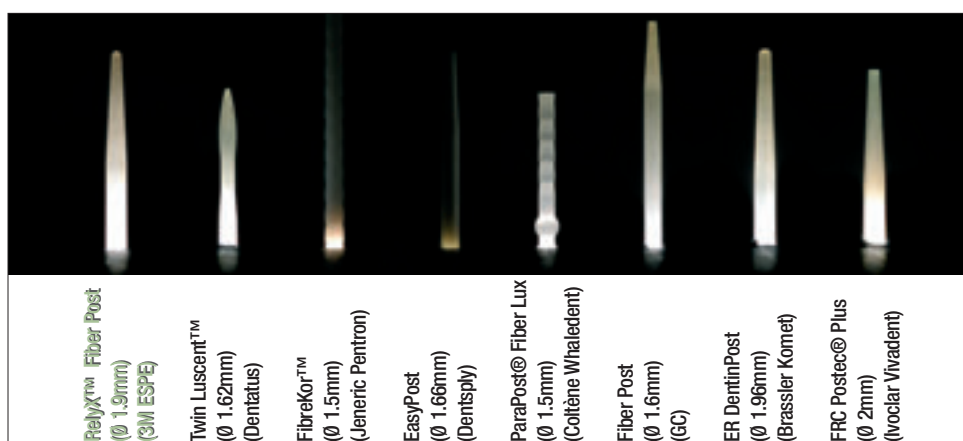

Fig. 3: Light transmission in various brands of fiber reinforced posts lit from the coronal end. (3M ESPE internal data)

3.2.2. Elasticity

The “wedge effect” of root posts (Lit. 1) can be overcome when the cemented root post and the surrounding root canal dentin represent a system with uniform mechanical properties. A prerequisite is that the modulus of elasticity (Young’s Modulus) of all system components are similar to each other. The higher a material’s modulus of elasticity the less flexible it is. The modulus of elasticity for RelyX™ Fiber Post Glass Fiber Posts is in the same range as that of dentin while the modulus of metal and ceramic posts are many times higher (Fig. 4).

Elasticity modulus (GPa) of dentin and post materials

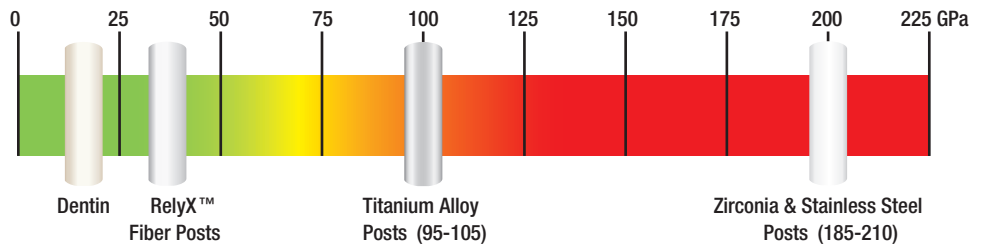
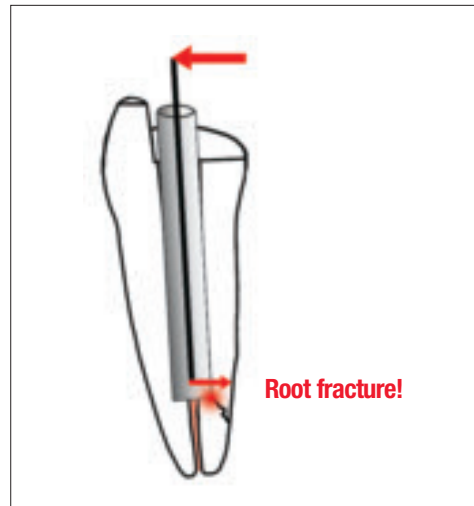

Fig. 4: Elasticity modulus (GPa) of dentin and post materials. (3M ESPE internal data and Lit. 2)

Due to this similarity of elastic properties, RelyX Fiber Posts are able to distribute the forces taken up at the corona evenly and attenuated to the root without causing peak forces – unlike metal posts – that may lead to root fractures (Fig. 5). The tapered shape of the RelyX Fiber Posts further contributes to this effect.

Metal posts



Fiber reinforced posts

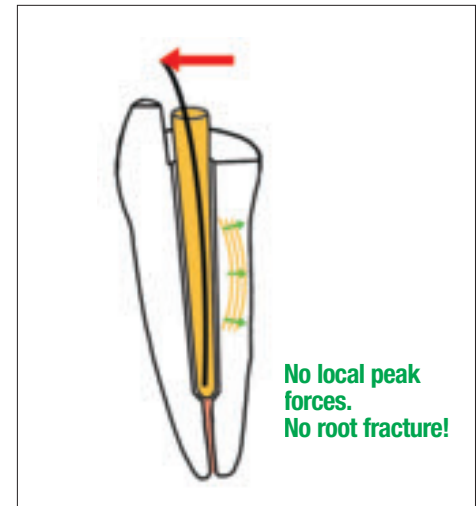
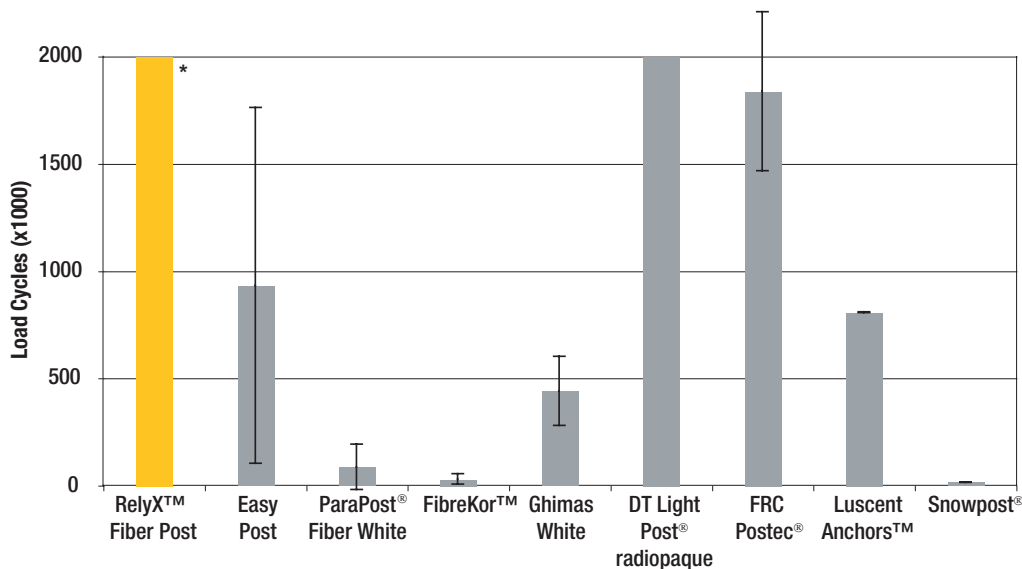

Fig. 5: Root fractures may result from root posts with low flexibility like metal posts (left) that transmit forces from the coronal end deep into the tooth. In contrast, due to their elastic properties fiber reinforced posts are able to spread such forces along the post (right).

3.3. The Long-Lasting Post

3.3.1. Fatigue Test

Root posts need to withstand repeating mastication load over a long period of time. In order to test their long-term stability root posts are subjected to cyclic loading comparable to mastication simulation. RelyX™ Fiber Post showed excellent fatigue resistance. In contrast to the other posts tested here (Fig. 6) no RelyX Fiber Post broke during this comparative test (2,000,000 cycles, 10 posts per brand tested). For the RelyX Fiber Post the test was continued until 5,000,000 cycles were reached. Still no RelyX Fiber Post failed.



* For RelyX Fiber Post the test was continued until 5,000,000 cycles were reached. Still no RelyX Fiber Post failed.

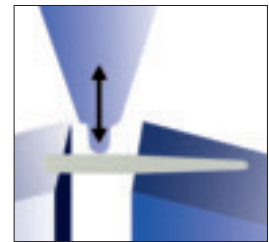

Schematic depiction of the fatigue test setup. The root post is fixed at both ends of the cylindrical part of the post. Then a cyclic load is applied centrally.

Fig. 6: In the fatigue test RelyX™ Fiber Posts survived more than 2,000,000 load cycles without breaking. (Study by Prof. Ferrari, University of Siena, Italy, Lit. 3)

3.3.2. 1-Point Flexural Strength Test

Next to the preparation technique (“ferrule design”) the flexural strength of the root post contributes to the overall stability of the restoration. The flexural strength of RelyX Fiber Posts equals or exceeds other brands (Fig. 7).

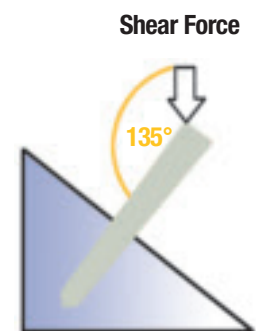
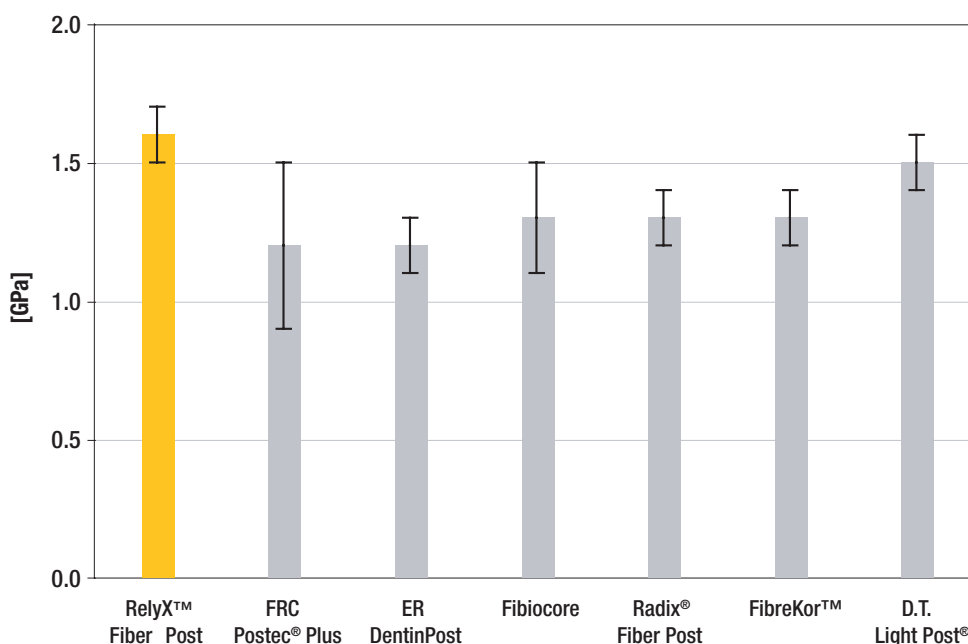

Schematic depiction of the 1-point flexural strength test setup. The root posts are loaded at an angle of 135 degrees until breakage occurs.

Fig. 7: 1-point flexural strength testing of RelyX™ Fiber Posts and other brands. (3M ESPE internal data)

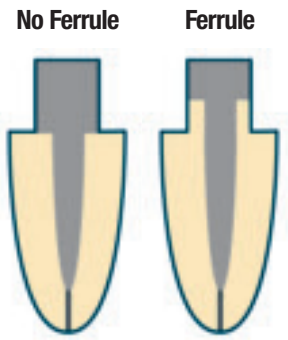

Coronal extension of dentin (yellow) above the shoulder provides an effective ferrule. The restorative material is depicted in grey.

Fig. 8: The 1-point flexural strength of RelyX™ Fiber Posts stays unaffectedly high even after 10,000 thermocycles (5°C / 55°C). (3M ESPE internal data)

Thermocycling tests assess the long-term stability under simulated aging conditions. RelyX™ Fiber Posts show high flexural strength values even after 10,000 thermocycles (Fig. 8) and thereby meet a key prerequisite for the longevity of restorations.

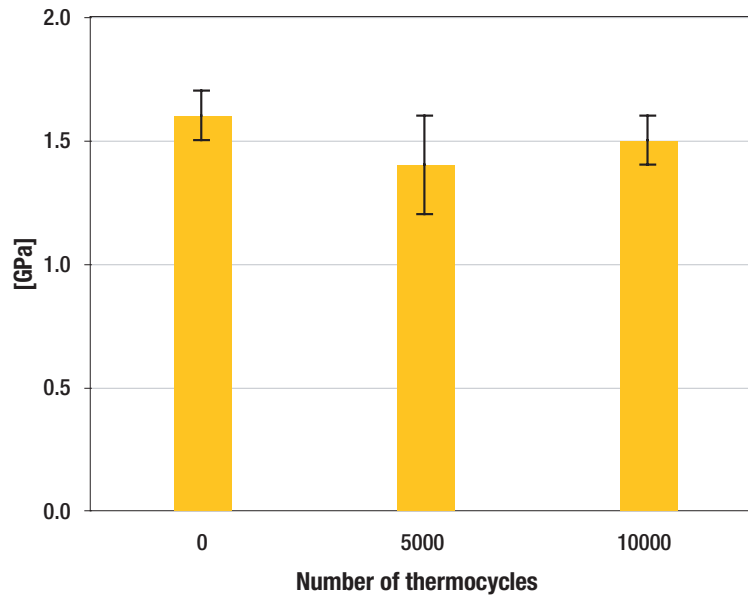

3.4. The Best Way to Cement It

RelyX™ Unicem Self-Adhesive Universal Resin Cement adheres to RelyX™ Fiber Post Glass Fiber Posts in 3 ways:

- Mechanical interlocking
- Covalent bonds
- Hydrogen bonds

During the manufacturing process RelyX Fiber Posts obtain a microporous surface (Fig. 9). The resulting indentations serve as micro-retentions when they fill up with cement. Mechanical interlocking contributes the most to the adhesive strength between the post and the cement. Apart from this, the composite matrices of RelyX Fiber Posts and RelyX Unicem cement are chemically compatible. Therefore, covalent, i.e. chemical bonds are established between RelyX Unicem cement and RelyX Fiber Posts. Additional adhesion is provided by non-covalent hydrogen bonds which develop between the RelyX Unicem cement and RelyX Fiber Post molecules.

Due to these effects high bond strength values are achieved between RelyX Unicem cement and RelyX Fiber Post without any chemical (e.g. silanating) or mechanical pretreatment (e.g. roughening) of RelyX Fiber Post. This differentiates the RelyX Fiber Post / RelyX Unicem cement system from other combinations of fiber reinforced posts and cements.

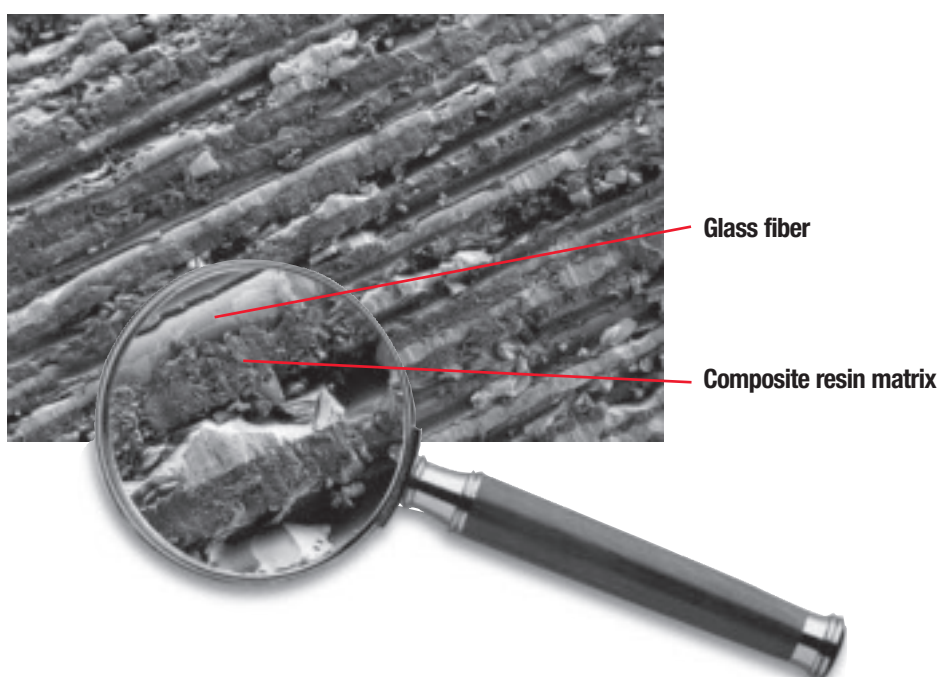
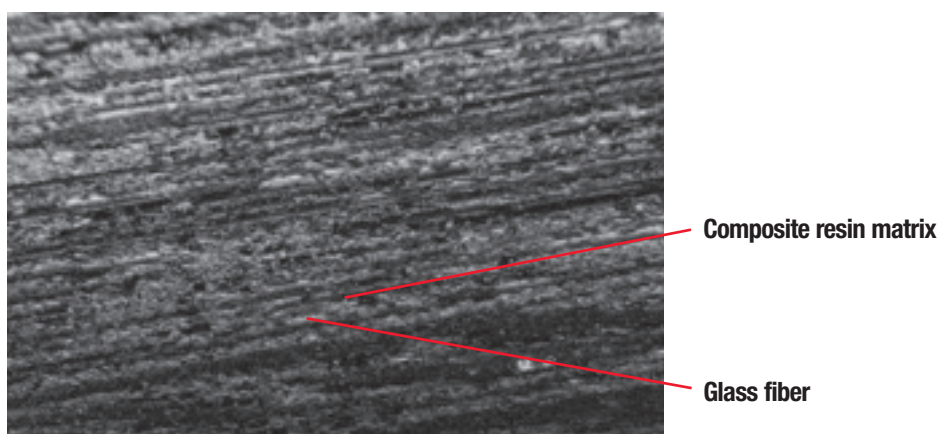

Fig. 9: The surface of RelyX™ Fiber Posts is microporous. The glass fibers are visible as light gray lines between the composite matrix. (SEM images, magnification 100x, upper; 500x, lower; 1000x, magnifying glass). (3M ESPE internal data)

3.4.1. The Reliable Bond

Adhesion of RelyX™ Unicem Self-Adhesive Universal Resin Cement to RelyX™ Fiber Post

RelyX Unicem cement shows consistently high bond strength values to RelyX Fiber Posts **without** the need for post pretreatment (Fig. 10) such as etching, silanating (e. g. RelyX™ Ceramic Primer, 3M ESPE, or Monobond-S, Ivoclar Vivadent), or a combination of silicization (Rocatec™ System, 3M ESPE) and silanating. For determining bond strength RelyX Unicem cement was applied to the post surface in a disc shaped mold (d = 6.0mm, h = 4.0mm) at the conical part of the posts (Fig. 11). RelyX Unicem cement was light-cured for 40 seconds and water stored (24hrs at 36°C) before bond strength was measured in a pull-off setup.

Fig. 10: Tensile bond strength (24hrs) of RelyX™ Unicem Cement to RelyX™ Fiber Post with and without fiber post pretreatment. (3M ESPE internal data)

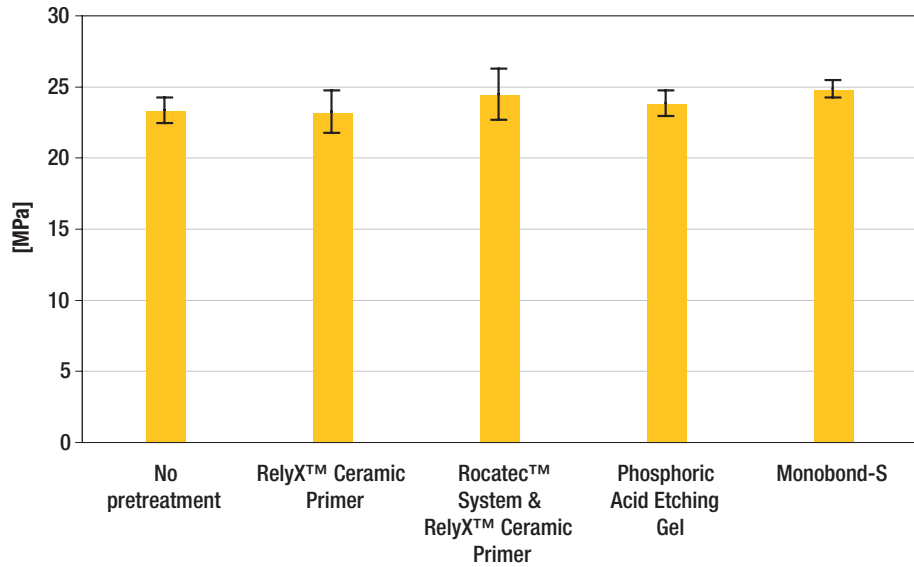
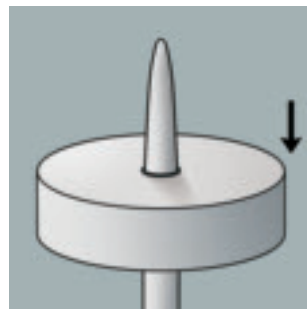
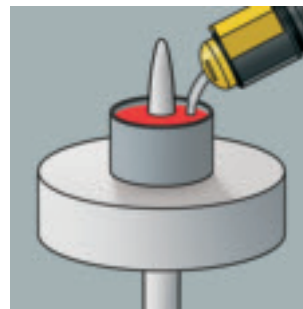

Fig. 11: Simplified depiction of a set-up to determine the tensile bond strength on root canal posts.



A plastic carrier is slipped onto the conical end of the post. Each sample shows the same length of the post tip.



A standardized mold on the plastic carrier is used to apply the same amount of cement to each of the samples.

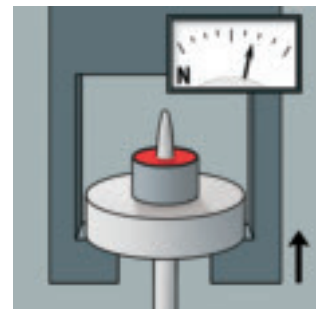

After curing, the cement disc is pulled off in a universal testing machine.

Independent of the curing mode (self- or light-curing) RelyX™ Unicem Cement develops high bond strength to RelyX™ Fiber Post Glass Fiber Posts without the need of prior post pretreatment (Fig. 12). Bond strength values of other adhesive cements are comparably high only if the cement was light-cured and, for some cements, if the posts were treated with bonding agent before cementation. Testing conditions were as described above. Cements were either self-cured (stored for 1hr at 36°C / >95% r. h.) or light-cured (RelyX™ Unicem Cement and Maxcem™ cement 40 seconds, Multilink® Automix and Variolink® II 60 seconds). After curing all samples were stored in water at 36°C. Again, bond strength was measured in a pull-off setup 24 hours after applying the cements.

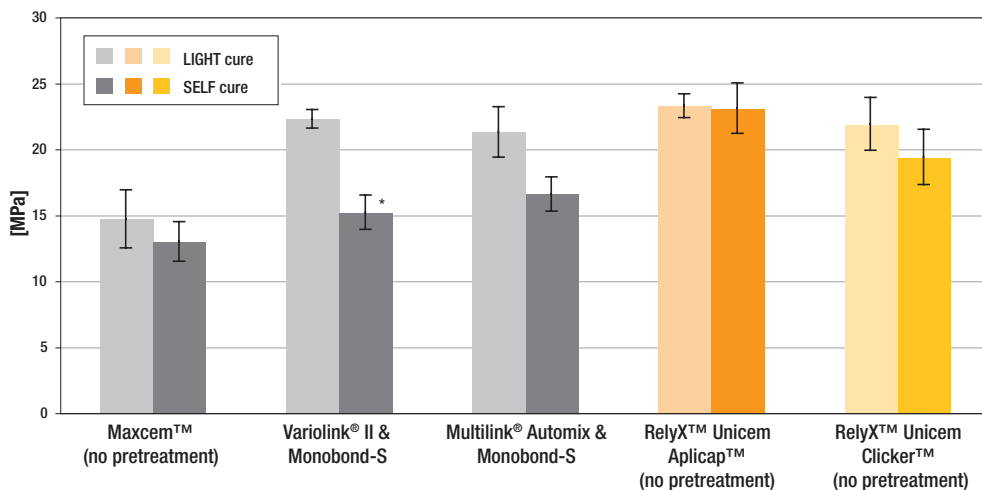

* The manufacturer does not recommend self curing for Variolink II

Fig.12: Tensile bond strength of RelyX™ Unicem Cement to RelyX™ Fiber Post (size 3) in comparison to other resin cements. (3M ESPE internal data)

Adhesion of RelyX™ Unicem Self-Adhesive Universal Resin Cement to Root Dentin

Since its market introduction in 2002 numerous *in vivo* and *in vitro* studies as well as evaluations of independent research institutes proved the cementation with RelyX Unicem cement to be safe and reliable. A microtensile bond strength study to both bovine crown and root dentin from the University of North Carolina (Lit. 4) showed RelyX™ Unicem Cement in the Aplicap™ Capsule had higher adhesion values than other brands (Fig. 13). For testing, incisors were ground with 600 grit silicon carbide, pretreated according to manufacturers' instructions, and the luting cement was applied and cured. After water storage (24hrs at 36°C) the bond strength was tested using 1mm x 1mm beams.

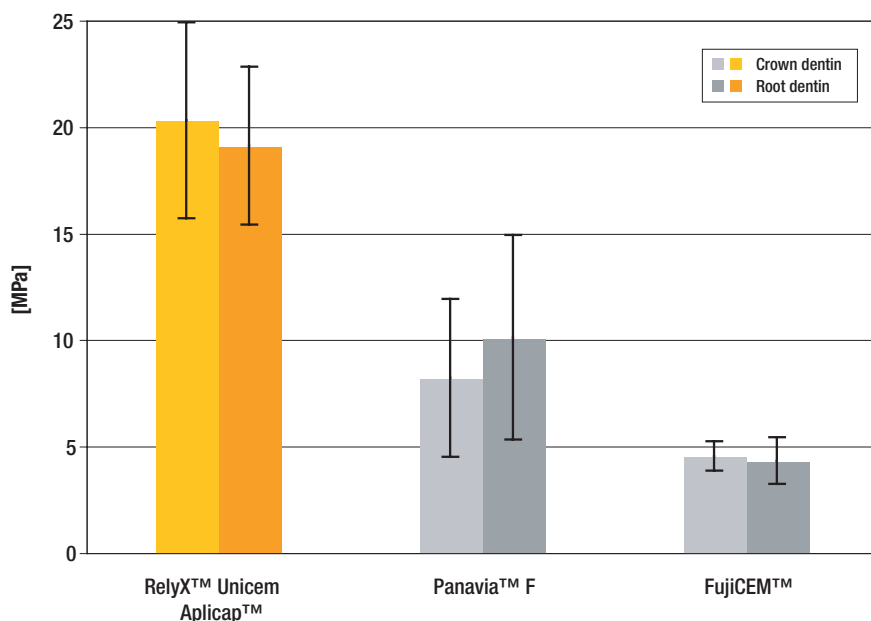

For further information see RelyX™ Unicem Technical Product Profile

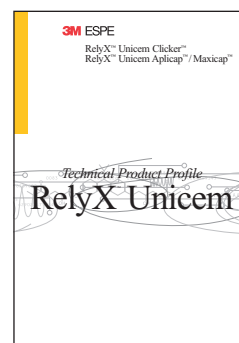

Fig. 13: Micro tensile bond strength of RelyX™ Unicem Cement and other resin cements to bovine crown and root dentin (Lit. 4).

In another study (Lit. 6) with extracted human teeth, the authors find higher pull-off adhesion values for fiber reinforced posts cemented with RelyX™ Unicem Self-Adhesive Universal Resin Cement than for those cemented with a conventional adhesive technique requiring etching and bonding.

Marginal Sealing in RelyX™ Fiber Post Treated Teeth

A good marginal seal is pivotal for the long-term success of the endodontic and the prosthodontic restoration by inhibiting bacterial infiltration (Lit. 7). In this study done by Prof. Ferrari at the University of Siena, Italy, extracted human anterior teeth were endodontically treated with guttapercha and a resin sealer (AH-25, DeTrey). Post spaces were prepared using the RelyX Fiber Post system drills. Cementation of the post was done according to the cement manufacturers' instructions for use using either RelyX Unicem self-adhesive cement (Aplicap™) or various brands of multi-step resin cements. RelyX Unicem cement was applied directly into the root canal using the RelyX™ Unicem Aplicap™ Elongation Tip. All other cements were applied to the post and/or the root canal using either a probe or a Lentulo spiral. After one week water storage microleakage between the canal wall and the cement layer was determined and SEM pictures (Fig. 14) of the cement layer were taken. RelyX Unicem cement in combination with RelyX Unicem Aplicap elongation tip and RelyX Fiber Post shows marginal sealing superior to other cement systems tested in this study.

Fig. 14: SEM pictures of the canal wall (top) / cement (middle) / fiber post (bottom) interface (Lit. 7). Left: RelyX™ Fiber Post cemented with RelyX™ Unicem Cement (Aplicap™) Right: RelyX™ Fiber Post cemented with a multi-step resin cement (here: Multilink® Automix, Ivoclar Vivadent).

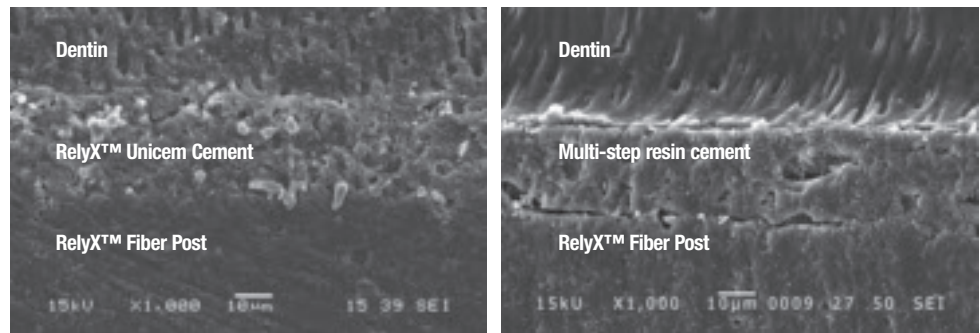

3.4.2. The Smart Application

Virtually Void-free Cement Application

The use of a lentulo spiral for cement application is not recommended with RelyX™ Unicem Cement as for many other resin cements because of the possible curing acceleration. Therefore, up to now the luting cement is applied to the post surface extra-orally. Then the post covered with the cement is seated in the root canal. However, this method may cause voids being trapped in the cement layer which may impact both the bond strength and the proper seal of the cement layer in a negative way. In order to avoid this effect an elongation tip for the RelyX™ Unicem Aplicap™ was developed which can be attached to the Aplicap nozzle and securely locks via a snap mechanism (page 17, picture 13). The elongation tip allows bottom to top filling of root canals. Keeping the elongation tip immersed in the cement during root canal filling reduces the chance of trapping air bubbles and creating voids.

This has also been proven in a study conducted at the University of Berlin (Lit. 5). Light and electron microscopy images (Fig. 15) show a significantly reduced number of voids in the cement layer around posts when the RelyX Unicem Aplicap elongation tip technique was used instead of a conventional technique where the cement is applied to the post before it is seated.

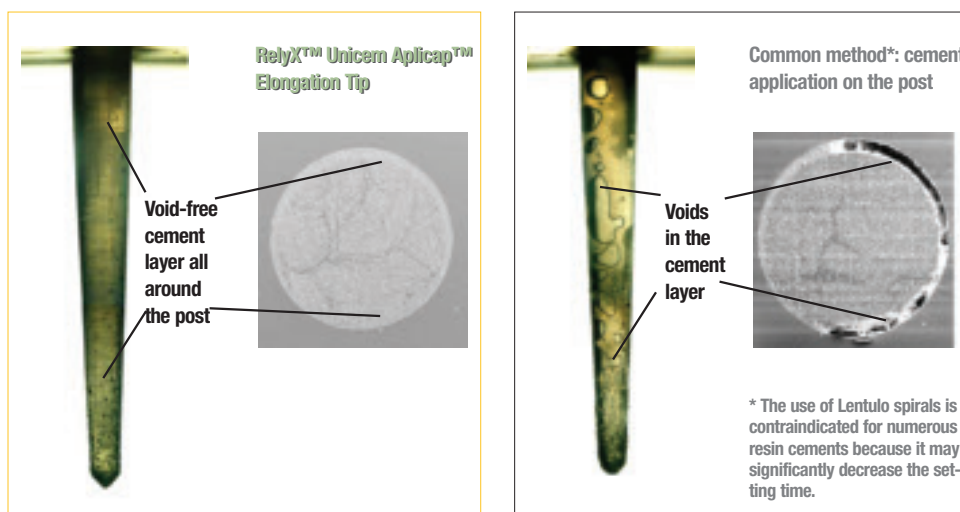

Fig. 15: The method of cement application determines the number of voids. Light microscopy and SEM images (cross section) of a simulated root canal filling in an acrylic glass test device (Lit. 5).

Left: A simulated root canal filled with RelyX™ Unicem Cement using the new RelyX™ Unicem Aplicap™ Elongation Tip.

Right: Resin cement applied using a common method of applying the cement onto the posts before placement. Voids, which can compromise bond strength, are clearly visible in the cement layer around the post.

3.5. The Secure Core

To achieve a secure bond between the composite core build up material and the RelyX™ Fiber Post it is sufficient to apply the respective bonding system to the post and the surrounding tooth structure as recommended by the manufacturer. After cementation and cleaning off excess cement (see Technique Guide page 17f) the coronal part of the post is treated with the bonding agent.

For 3M ESPE composite materials (e.g. Filtek™ Supreme XT Universal Restorative, Filtek™ Z250 Universal Restorative System, Filtek™ P60 Posterior Restorative System, Z100™ MP Restorative System and others; see Fig. 17), 3M ESPE bonding agents such as Adper™ Easy Bond Self-Etch Adhesive, Adper™ Prompt™ L-Pop™, Adper™ Scotchbond™ 1 XT, or Adper™ Scotchbond™ Multi-Purpose are recommended. The adhesion test data (Fig. 16) shows that silanating (e.g. with RelyX™ Ceramic Primer, 3M ESPE) can be omitted without a negative impact on bond strength.

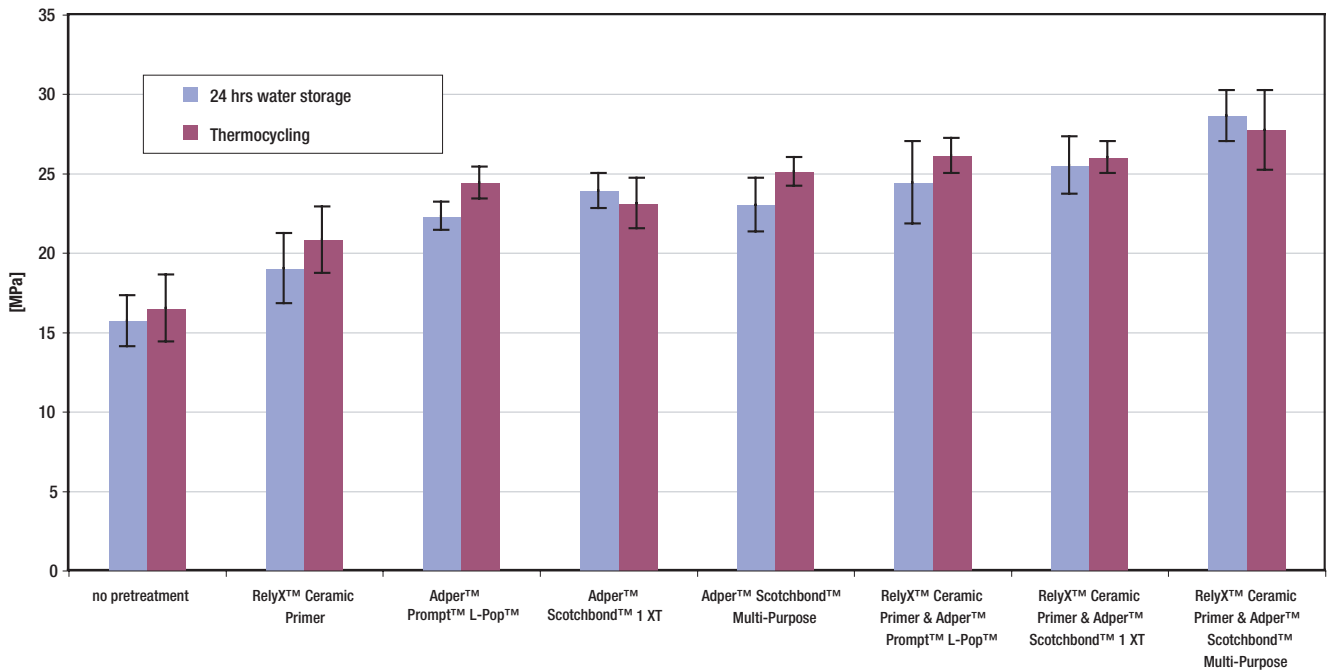

Fig. 16: Influence of different post pretreatment methods on bond strength values for Filtek™ Z250 Universal Restorative System on RelyX™ Fiber Posts. Adhesion was tested at the conical part of the posts and measured in a pull-off setup. Tests were performed after water storage (24hrs at 36°C) only or additional thermocycling (5,000 cycles 5°C / 55°C). (3M ESPE internal data)

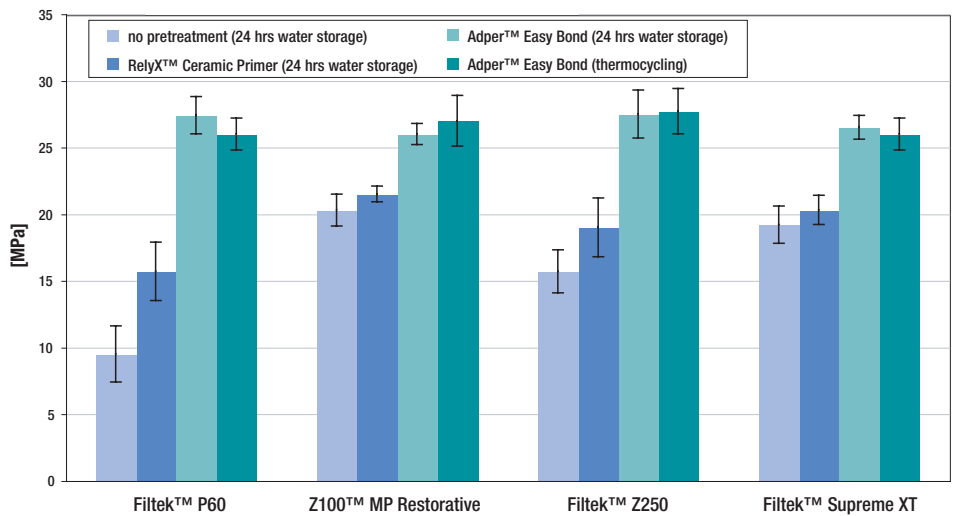

Fig. 17: Bond strength values of various Filtek™ restorative composite filling materials and different post pretreatment methods to RelyX™ Fiber Posts. Test details see Fig. 16. (3M ESPE internal data)

4. Technique Guide

3M ESPE

RelyX™ Fiber Post

Glass Fiber Post

RelyX™ Unicem Aplicap™

Self-adhesive Universal Resin Cement

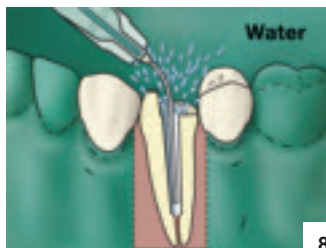
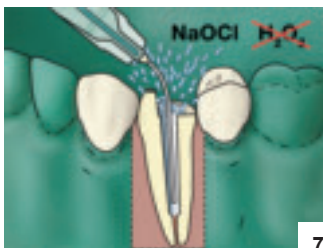
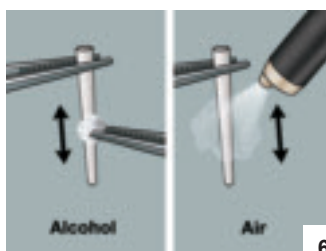
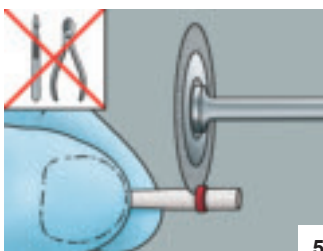
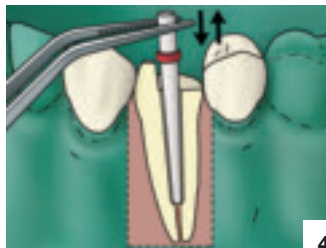
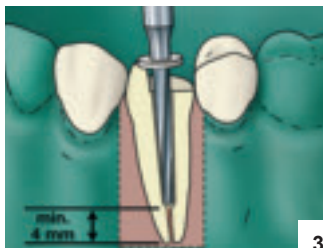
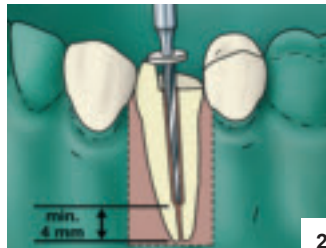
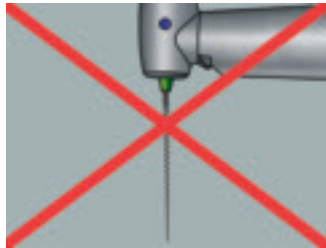
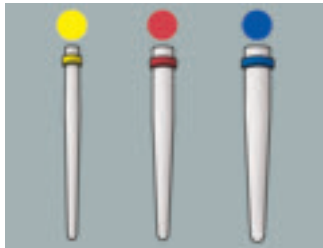

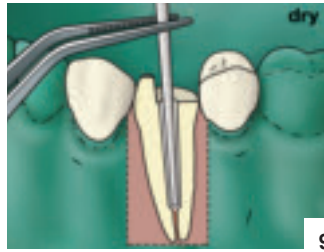

9

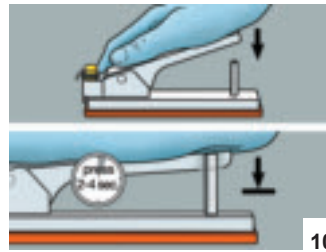

10

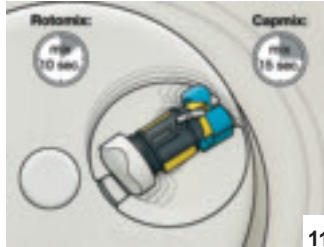

11



12

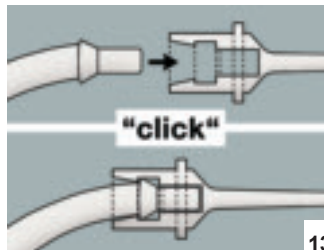

13

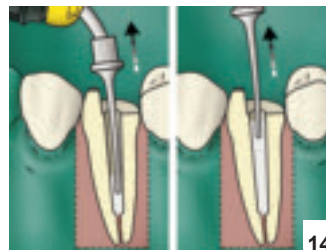

14

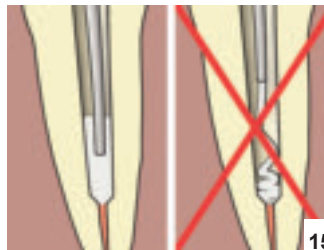

15

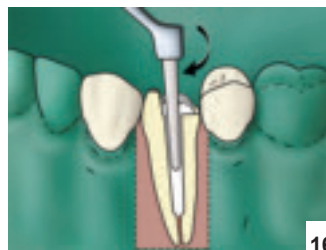

16

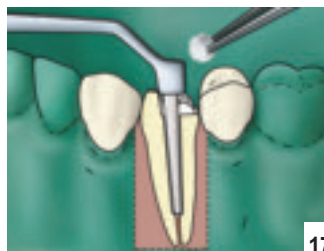

17

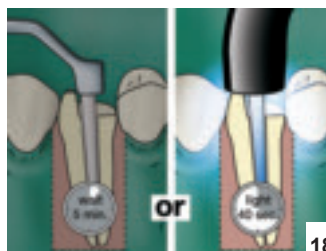

18

3M ESPE

3M ESPE AG
Dental Products
82229 Seefeld - Germany

3M ESPE
Dental Products
St. Paul, MN 55144-1000

3M, ESPE, Aplicap, CapMix, RelyX and RotoMix are trademarks of 3M or 3M ESPE AG.
© 3M 2007. All rights reserved.



44000750016/02 (September 2007)

5. Literature

Lit. 1: Stadler P, Wimmershoff M., Shookoi H., Wernisch J.: The stress transmission of prefabricated root canal posts; Schweiz Monatsschr Zahnmed. 1995; 105 (11), p.1418-24.

Lit. 2: Callister W.D.: Materials Science And Engineering. An Introduction. 5th Ed., Wiley, New York, p.793-795

Lit. 3: Study by Prof. Ferrari, University of Siena, Italy, 2006, submitted for publication

Lit. 4: Walter R., Miguez P.A., Pereira P.N.R., University of North Carolina, Chapel Hill, USA; Bond Strengths of Resin Luting Materials to Crown and Root Dentin; IADR 2003, Gothenburg Sweden, #1463

Lit. 5: Watzke R., Blunck U., Frankenberger R., Naumann M.: Interface homogeneity of adhesively luted glass fiber posts, Dental Materials In Press, Available online 7 May 2008

Lit. 6: Bateman G.J., Chadwick R.G., Saunders W.P.H., Lloyd C.H.: Retention of Quartz-Fibre Endodontic Posts with a Self-Adhesive Dual Cure Resin Cement; Eur J Prosthodont Restor Dent. 2005 Mar 13(1), p.33-7

Lit. 7: Simonetti M., Coniglio I., Magni E., Cagidiaco M.C., Ferrari M.: Sealing Ability and Microscopic Aspects of a Self-adhesive Resin Cement used for Fiber Post Luting into Root Canals; Dept. Dental Materials, International Dentistry SA Vol. 8, No. 5, Sept./Oct. 2006

Lit. 8: Fischer D.E.: Benefits of Fiber Post; Dentistry Today, Feb 2008, p. 138-144

Lit. 9: Wong F.S.L., Pirvani M., Parker S.: Bond strength of two glass-fibre post systems in root canals; BARTS and The London School of Medicine and Dentistry, United Kingdom; 86th IADR 2008, Toronto, Canada, abstract #0124

Lit. 10: Radovic I., Mazzitelli C., Chieffi N., Ferrari M.: Adhesion of Fiber Posts Cemented Using Different Adhesive Approaches; University of Belgrade, Serbia and Montenegro; University of Siena, Italy; 86th IADR 2008, Toronto, Canada, abstract #1750

Lit. 11: Zicari F., Van Meerbeek B., Scotti R., Naert I.: Influence of surface treatment on bonding effectiveness of different fiber-posts; Catholic University of Leuven, Belgium; Leuven BIOMAT Research Cluster, Catholic University of Leuven, Belgium; University of Bologna, Italy; 86th IADR 2008, Toronto, Canada, abstract #2852

Lit. 12: Meador M., Broome J., Ramp L.: Diametral tensile bond strength of resin composite to fiber-posts; University of Alabama, Birmingham, USA; UAB School of Dentistry, Birmingham, AL, USA, 85th IADR 2007, New Orleans, USA, abstract #0867

Lit 13: Peez R., Porsfeld V., Lachermeier B., Braun P.: Adhesion of Filtek P60 to RelyX Fiber Post; 3M ESPE AG, Seefeld, Germany; 85th IADR, New Orleans, USA, abstract #1527

Lit. 14: Bitter K., Perdigao J., Hartwig C., Paris S., Kielbassa A.: Nanoleakage of luting agents for bonding post after thermo-mechanical fatigue; Charite, Universitaetsmedizin Berlin, Germany, University of Minnesota, Minneapolis, MN, USA; 86th IADR 2008, Toronto, Canada, abstract #0971

Lit. 15: Dasch W., El-Aryan M., Roggendorf M.J., Ebert J., Petschelt A., Frankenberger R.: Leakage of Different Luting Cements for Quartz-fiber Post Cementation University of Erlangen-Nuremberg, Germany; 86th IADR 2008, Toronto, Canada, abstract #3141

Lit 16: Kqiku L., Städtler P., Gruber H.J.: Microleakage along RelyX fiber posts cemented with different materials; University Dental Clinic, Graz, Austria; Medical University, Graz, Austria; 42th CED 2007, Thessaloniki, Greece, abstract # 0213

You + 3M ESPE =
A formula for success

3M ESPE

Dental Products

3M Center
Building 275-2SE-03
St. Paul, MN 55144-1000
U.S.A.
1-800-634-2249

3M ESPE AG
ESPE Platz
82229 Seefeld
Germany
E-Mail: info3mespe@mmm.com
Internet: www.3mespe.com

3M, ESPE, Adper, Aplicap, Filtek, L-Pop, Prompt, RelyX, Rocatec, and Scotchbond, are trademarks of 3M or 3M ESPE AG.

Anchor, FibreKor, Light Post, Maxcem, Multilink, ParaPost, Postec, Radix, Snowpost, Panavia, and Variolink are not trademarks of 3M or 3M ESPE AG.

© 3M 2009. All rights reserved.
70200953852/02 (04.2009)